

CORALIFE®

# TURBO-TWIST®

## UV STERILIZER

---

### Instructions



**Please read these instructions in their entirety  
before attempting to use this product.**

EPA Estab. No. 073048-CA-00

**Coralife®**

A product of Central Aquatics  
(Division of Central Garden & Pet Co.)  
Franklin, WI 53132 888.255.4527

Coralife® and Turbo-Twist® are registered  
trademarks of Central Garden & Pet Co.

© 2011 Central Garden & Pet Co.

# PARTS DIAGRAM

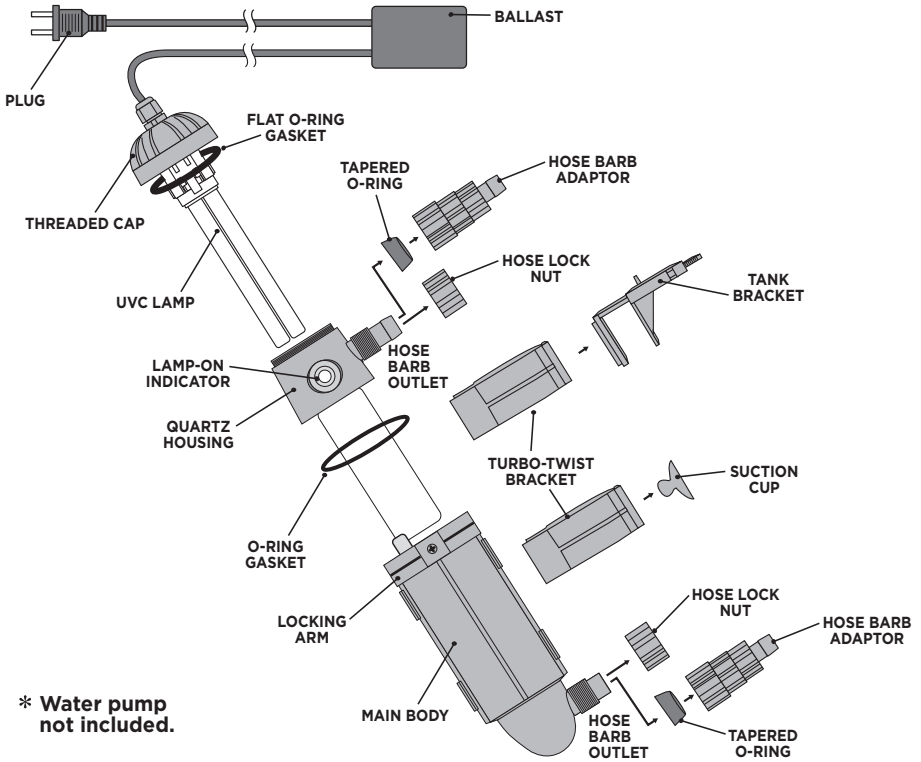

# SPECIFICATIONS

Article	Turbo-Twist 3x	Turbo-Twist 6x	Turbo-Twist 12x
UVC Lamp	9 watt	18 watt	36 watt
Rated Voltage	AC120V	AC120V	AC120V
Rated Cycle	60Hz	60Hz	60Hz
Rated Power	10.2 watt	19 watt	38 watt
Irradiation of UVC Radiation*	9,580 $\mu\text{W}/\text{cm}^2$	11,400 $\mu\text{W}/\text{cm}^2$	11,400 $\mu\text{W}/\text{cm}^2$
Wavelength of Radiation	253.7nm	253.7nm	253.7nm
Life of UVC Lamp	Approx. 8,000 hrs	Approx. 8,000 hrs	Approx. 8,000 hrs
Aquarium Volume	Up to 125 gals	Up to 250 gals	Up to 500 gals
Flow Rate (gallons per hour)	100-200 gph	200-400 gph	400-1200 gph
Hose sizes	1/2", 5/8"	5/8", 3/4"	3/4", 1", 1-1/4"
Cord Length	Approx. 9 ft	Approx. 9 ft	Approx. 9 ft

\*(value @ 20mm distance from the UVC lamp)

The Coralife Turbo-Twist Ultraviolet Sterilizers are easy to set up and operate. Please read all instructions in their entirety before installation.

To accommodate your new sterilizer, you will need a power-head, pump, or canister filter with an appropriate flow rate for the size of your UV Sterilizer to ensure adequate ultraviolet exposure while treating the entire volume of aquarium water with appropriate frequency.

# INSTRUCTIONS

## 1. Set up and positioning

### Adjusting the hose barb inlet and outlet

The hose barbs can be positioned in four different locations to facilitate connections to other applications.

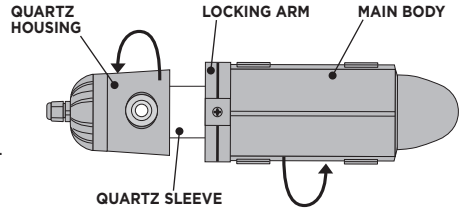

- ① Unscrew locking ring screw and slide tab down to release. (Picture 1)
- ② Carefully twist the quartz housing and the main body opposite of each other. (Picture 2)
- ③ Slide the quartz sleeve out of the main body. (Picture 3)
- ④ Reinstall locking ring and tighten screw.

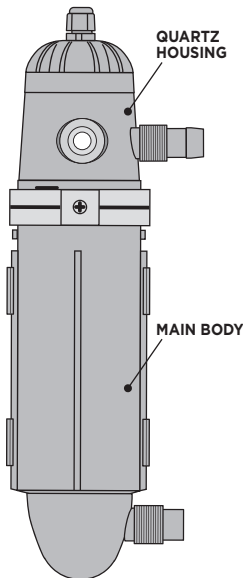

(PICTURE 1)

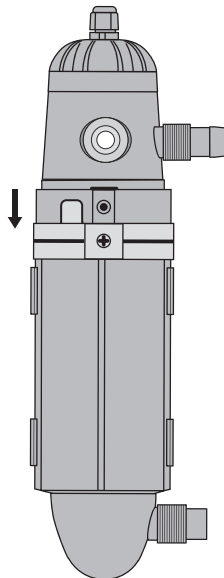

(PICTURE 2)

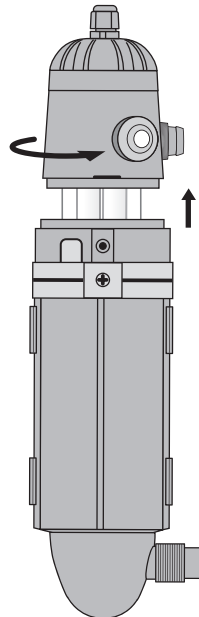

(PICTURE 3)

## Bracket Installation

- ① Adjust the tank bracket so that it hangs on the outside of the aquarium.

### RANGE OF THE CLAMP

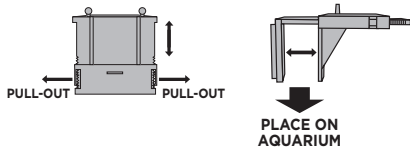

- ② Slide the Turbo-Twist bracket onto the tank bracket. Make sure the Turbo-Twist bracket is securely fastened onto the tank bracket.

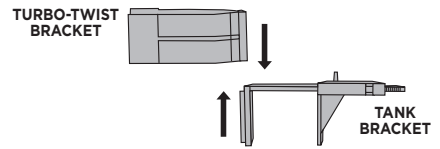

- ③ Snap the main body into the bracket indicated by a "click". Snap the other bracket with the suction cup in the same way.

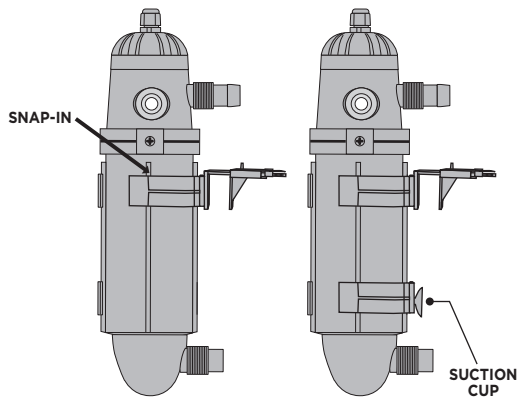
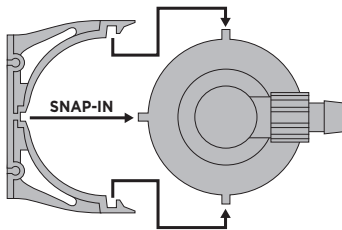

- ④ For horizontal positioning, take the suction cup out and snap the main body into the brackets until it locks with a "click". Bracket may be secured to a level surface.

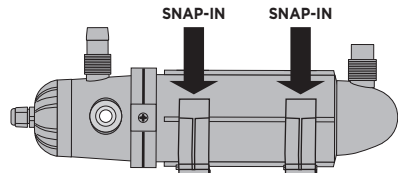

---

## 2. UVC Lamp installation

Remove threaded cap, install UVC lamp into socket until lamp "clicks" into place. Handle lamp with a clean cloth.

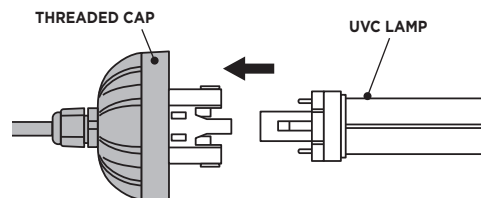

### 3. Reassembly

Make sure that the flat O-ring gasket is properly positioned inside the threaded cap (already installed in unit). Screw the threaded cap tightly back into place.

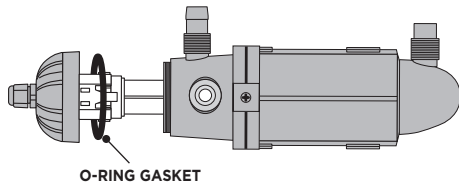

**Note:** The plug and cord should be turned together when screwing the threaded cap back into place.

### 4. Attaching the hose lock nuts

① Position the hose lock nuts on the hose-barb inlet and outlet.

② Use flexible tubing (not supplied) to connect the sterilizer to the water supply. Turn the hose lock nut counter-clockwise to tighten flexible tubing onto the hose barb. Hose lock nuts require only hand tightening.

HOSE LOCK NUT

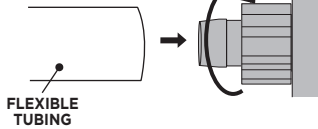
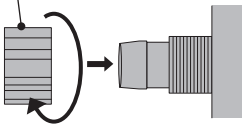

**Note:** Do not use O-ring when larger hose barbs are being used.

#### Hose barb adapter installation.

① Place the O-ring on hose barb inlet/outlet, watching for taper orientation.

② Hand tighten the hose barb adapter onto the Turbo-Twist.

③ Use flexible tubing to connect the sterilizer to the water supply. Turn the hose lock nut counter-clockwise to tighten flexible tubing onto the hose barb.

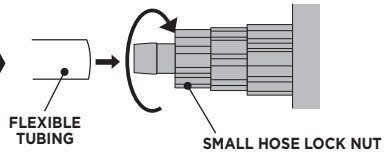
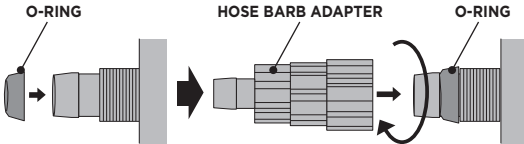

**Note:** Water will leak if the O-ring is not in place.

### 5. Installing the Turbo-Twist

#### Hang-on Positioning

Hang the unit using the Turbo-Twist bracket and suction cup on the outside of the aquarium. Adjust the tank bracket to secure the Turbo-Twist UV Sterilizer.

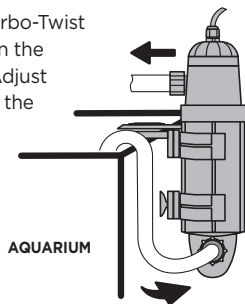

#### Horizontal Positioning

Attach Turbo-Twist bracket with screws on a fixed surface.

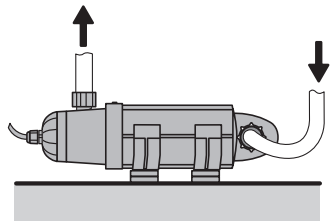

## 6. Tubing connection

Connect the tubing between the water flow outlet and the hose barb inlet.

It is recommended that a prefilter be used with the Turbo-Twist to limit the amount of debris entering the sterilizer.

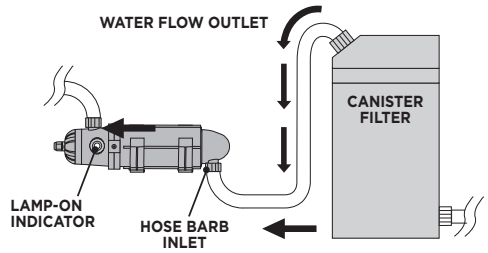

**Warning:**  
Never install a valve on the tubing between the main body and the aquarium.

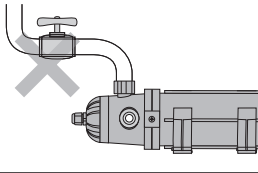

**Note:** Make sure that the tubing is not carrying the weight of the Turbo-Twist UV Sterilizer. Use the Turbo-Twist brackets to support the unit to a firm surface.

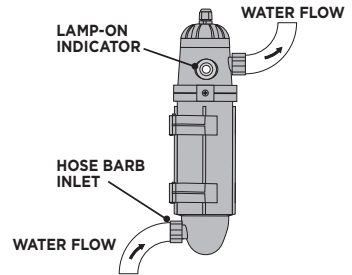

## 7. Start water flow

Turn on water supply to the Turbo-Twist. Once proper water flow has been established, tilt the unit and let the air bubbles inside the tubing and the main body escape. Examine the unit and check for any leaks.

## 8. Power up Turbo-Twist

Connect the Turbo-Twist to the power supply. Verify that the UVC lamp is working properly, indicated by the light blue glow emitted through the lamp-on indicator. The light from the lamp-on indicator will not affect the skin or the eye.

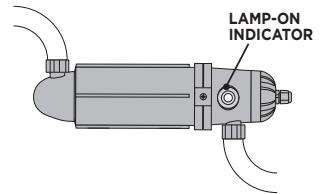

# CAUTION

- **Never look directly at the unshielded lamp as ultraviolet radiation is harmful.**
- **Disconnect the UV Sterilizer from the power supply when installing or performing maintenance.**
- **Never submerge the UV Sterilizer in water.**

# MAINTENANCE

To ensure superior performance, the quartz sleeve should be cleaned periodically.

## Cleaning the quartz sleeve

- 1 Disconnect UV Sterilizer from outlet, turn off the pump and let water drain from Turbo-Twist.

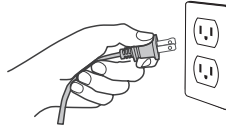

- 2 Unscrew locking ring screw and slide tab down to release. (Picture 1)
- 3 Carefully twist the quartz housing and the main body opposite of each other. (Picture 1)

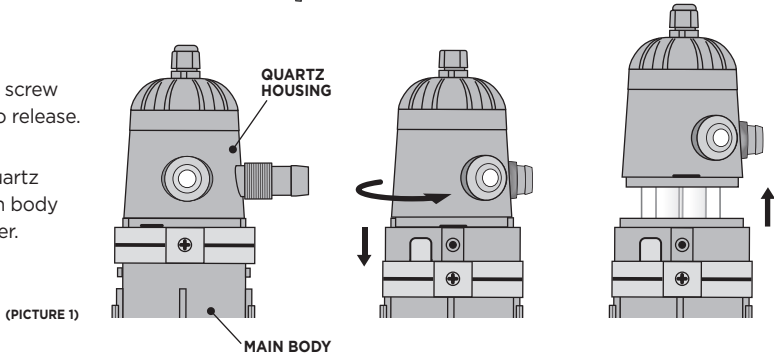

- 4 Slide the quartz sleeve out of the main body. (Picture 2)

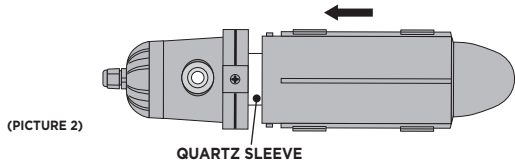

- 5 Wipe the quartz sleeve using a soft, damp cloth. Do not use household cleaners or abrasive scrubbers to clean the quartz housing.
- 6 Once clean, reinstall the quartz sleeve into the main body.
- 7 Reinstall locking ring and tighten screw.

## CAUTION

- Never look directly at the unshielded lamp as ultraviolet radiation is harmful.
- Disconnect the UV Sterilizer from the power supply when installing or performing maintenance.
- Never submerge the UV Sterilizer in water.

# Troubleshooting

If troubleshooting steps do not work, please contact Central Aquatics Tech Support for additional help.

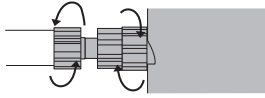
	PROBLEM	SOLUTION
<b>UVC Lamp is not working</b>	• The plug is not connected to the power supply.	• Connect the plug to the power supply.
	• UVC lamp base is loose.	• Carefully push the UVC lamp onto the socket until a "click" is heard.
	• The lamp has expired.	• Replace the UVC lamp.
<b>Water leak between the main body and hose lock nuts</b>	• The hose lock nut is loose.	• Tighten the hose barb or the hose lock nut. 
	• The O-ring is not in place.	• Install the O-ring.

## UVC LAMP REPLACEMENT

The UVC lamp has a useful life of about 12 months. To ensure effective performance, replace the UVC lamp once per year.

### How to replace the UVC lamp

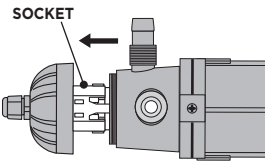
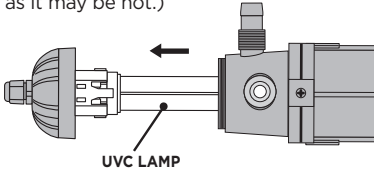
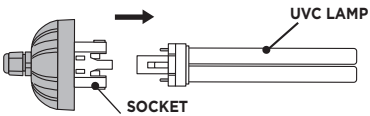
- ① Disconnect the sterilizer from the power supply. (It is also necessary to disconnect the power to the water pump.)
- ② Remove the threaded cap to expose the lamp socket.  

- ③ Pull the UVC lamp assembly out of the main body and allow to cool. (Be careful not to touch the lamp as it may be hot.)  

- ④ Once cool, pull the UVC lamp out of the socket.  

- ⑤ Make sure that the pins of the lamp plugs into the socket, indicated with a "click".
- ⑥ Reassemble the Turbo-Twist.

# WARNING

Please read instructions in their entirety before using the UV Sterilizer.

Cut off the power and stop using if the UV Sterilizer was submersed or dampened by water.



Cut off the power immediately if water enters into the quartz housing.



Cut off the power if there is a burning or smoking smell.



Never connect the sterilizer to the power outlet while hands are wet.



Never look directly at the unshielded lamp or allow prolonged exposure to skin as the ultraviolet radiation emitted from the lamp can be harmful.



Do not pull cord to disconnect power supply.



Always leave a drip loop in the power cord to prevent water from running down the length of the cord and reaching the power outlet.

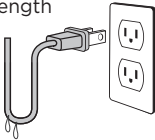

Though the Turbo-Twist is water resistant, it should never be intentionally submersed in water. Always install the sterilizer in a location where there is little likelihood of flooding or water dripping onto the UV Sterilizer.



The water temperature flowing through the UV Sterilizer should be below 105°F (40°C).



Make sure that appropriately-sized hose lock nuts are positioned on hose barbs before attempting to connect tubing.



Always disconnect the UV Sterilizer from the power supply before shutting down the flow of water to prevent overheating.



Only a 120V (60 Hz) electrical source should be used with the Turbo-Twist.



# Suggested Tubing Connections

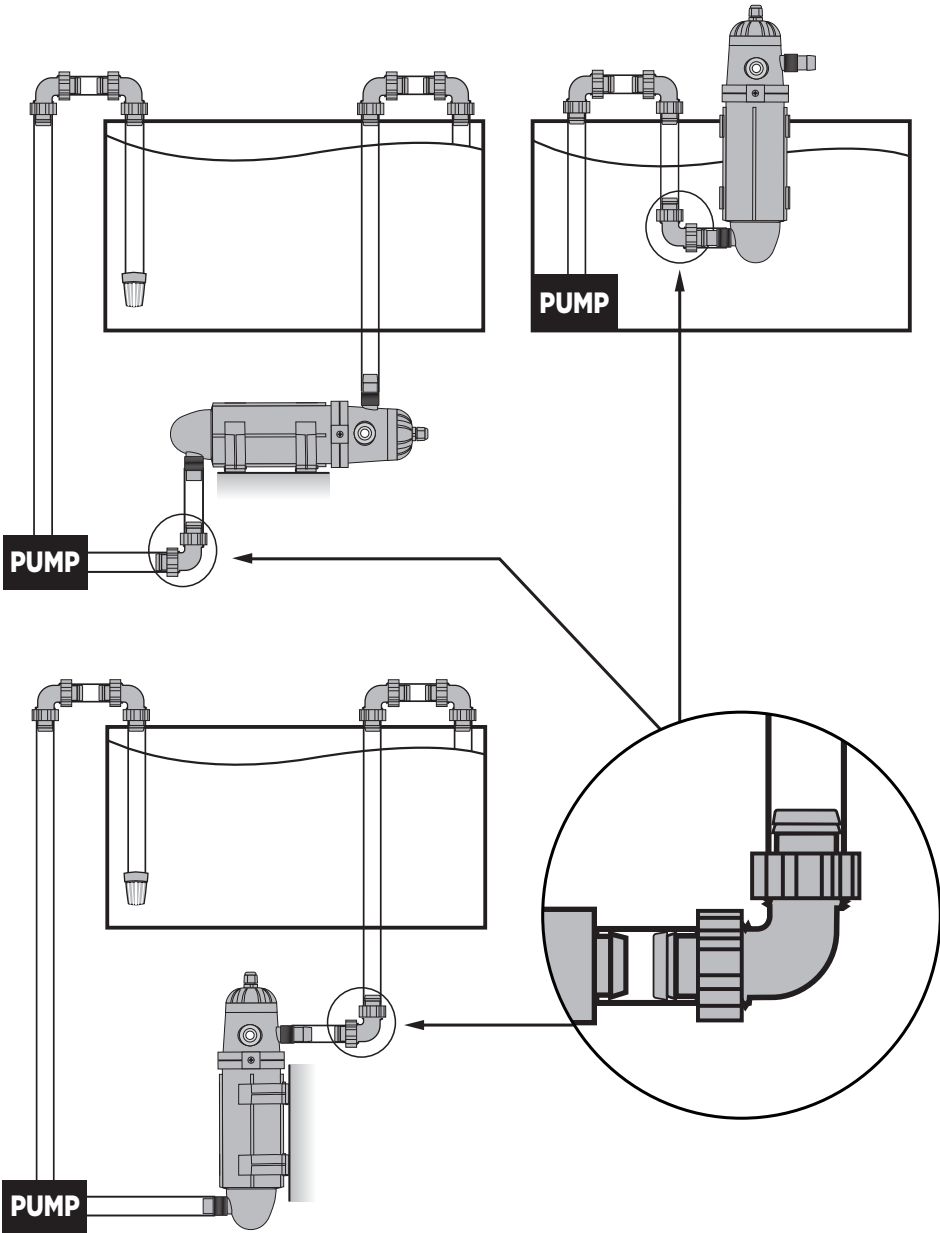

# Coralife Turbo-Twist® UV Sterilizer Flow Rates

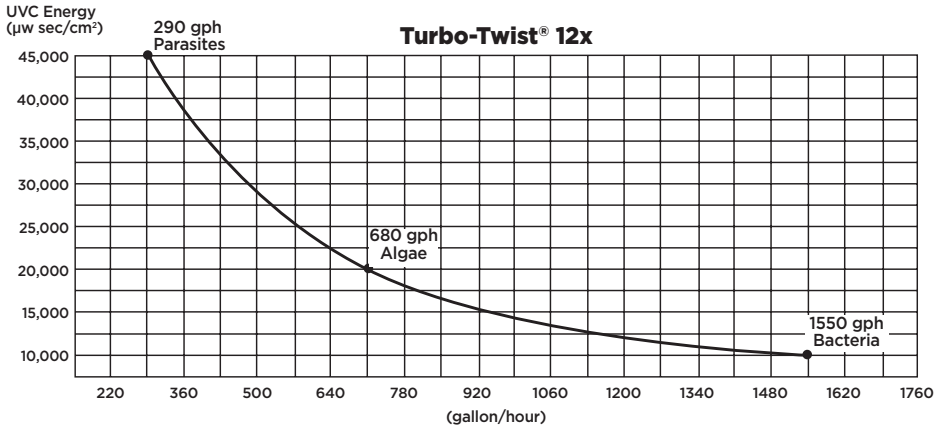
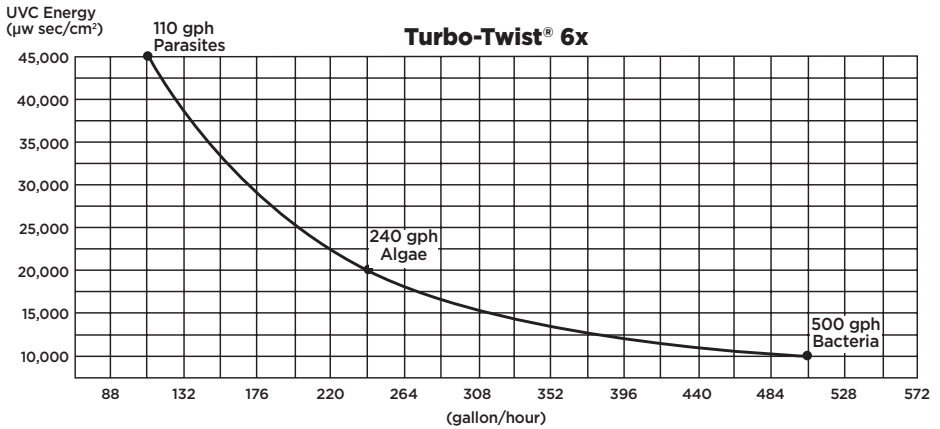
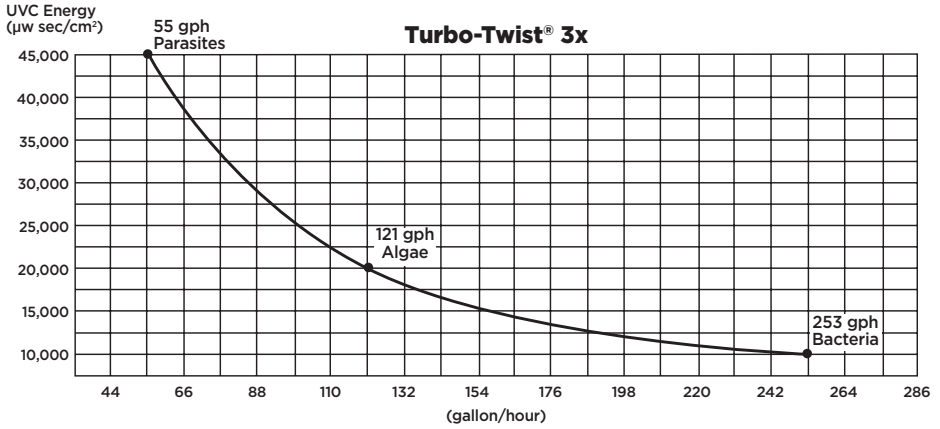

# TURBO-TWIST®

## UV STERILIZER

---

### 12 Month Limited Warranty

#### WHAT THE WARRANTY COVERS:

Central Aquatics (Company) warrants this product (see Exclusions below) to the original purchaser against defective material and workmanship that occurs during normal use for 12 months from the date of original purchase. Company will, at Company's option, either repair or replace product or part without charge (but no cash refunds will be made).

#### EXCLUSIONS:

1. Damage resulting from accident, misuse, abuse, lack of reasonable care, subjecting the product to any but the specified electrical service, other than normal and ordinary use of the product, subjecting the product to abnormal working conditions or any other failure not resulting from defects in materials or workmanship.
2. Damage resulting from modification, tampering with or attempted repair by anyone other than the Company.
3. Transfer of product to someone other than the original consumer purchaser.
4. UVC lamp is not covered under warranty.

#### WHAT YOU MUST DO TO ENFORCE WARRANTY:

1. Contact the Company by mail or telephone to obtain support under warranty:  
Central Aquatics, 5401 West Oakwood Park Drive, Franklin, WI 53132;  
E-mail: [info@central-aquatics.com](mailto:info@central-aquatics.com); Tel: 888-255-4527; Fax: 414-421-3530
2. Mail or ship the product, together with a copy of the original bill of sale, to:  
Central Aquatics  
5401 West Oakwood Park Drive  
Franklin, WI 53132  
Attn: Tech Dept.

You must pay any postage, shipping charges, insurance costs and other expenses to return the product to Central Aquatics, Franklin, WI. However, if the necessary repairs are covered by the warranty, Company will pay the return shipping charges to any destination within the United States or Canada.

#### LIMITATION OF IMPLIED WARRANTIES AND EXCLUSION OF CERTAIN DAMAGES:

THE COMPANY DISCLAIMS LIABILITY FOR INCIDENTAL AND CONSEQUENTIAL DAMAGES FOR BREACH OF ANY EXPRESS OR IMPLIED WARRANTY, INCLUDING ANY IMPLIED WARRANTY OF MERCHANTABILITY, WITH RESPECT TO THIS PRODUCT. THIS WRITING CONSTITUTES THE ENTIRE AGREEMENT OF THE PARTIES WITH RESPECT TO THE SUBJECT MATTER HEREOF; NO WAIVER OR AMENDMENT SHALL BE VALID UNLESS IN WRITING SIGNED BY THE COMPANY. Some states do not allow the exclusion or limitation of consequential damages, so the above limitation or exclusion may not apply to you.